



Constant Current & Dimmable Driver

Model: CC30WXXX-XXXCG Triac



Model	Output Current	Input Current	Input Power	Output Power Range	PF	Efficiency	Output Voltage	No load Voltage
CC30W500-700CG Triac	500mA	0.13A	28W	13-21W	0.92	85%	26-42V	55V
	550mA	0.13A	30W	14.3-23.1W	0.92	85%	26-42V	55V
	600mA	0.16A	32W	15.6-25.2W	0.92	86%	26-42V	55V
	700mA	0.16A	36W	18.2-29.4W	0.92	86%	26-42V	55V
CC30W700-900CG Triac	700mA	0.13A	28W	11.2-19.6W	0.92	84%	16-28V	43V
	800mA	0.13A	30W	12.8-22.4W	0.92	84%	16-28V	43V
	850mA	0.16A	32W	13.6-23.8W	0.92	84%	16-28V	43V
	900mA	0.16A	36W	14.4-25.2W	0.92	84%	16-28V	43V

* Test result @230V, 50Hz, Full Load.

1. Parameters

Category	Item	Technical Norm
Features	Output Type	Constant Current
	Dimming Type	Phase dimming
	Dimming Range	10%-100%
	IP Grade	IP20
	Insulation Class	Class II
Input	Rated Input Voltage	220-240VAC_stable
	Range of Input Voltage	198-264VAC_stable or 180-280VDC_stable
	Frequency	50/60Hz
	Input Current	≤0.16A
	Input Power	≤36W
	Power Factor	≥0.92 (230VAC,full load)
	THD	≤20% (230VAC,full load)
	No-load Power Consumption	≤1W @230VAC
Output	Output Voltage	26-42V @CC30W500-700CG Triac 16-28V @CC30W700-900CG Triac
	Output Current	500mA/550mA/600mA/700mA @CC30W500-700CG Triac 700mA/800mA/850mA/900mA @CC30W700-900CG Triac
	No Load Voltage	55VDC Max. @CC30W500-700CG Triac

		43VDC Max. @CC30W700-900CG Triac
	Max. Output Power	29.4W
	Efficiency	≥84%
	Current Ripple (<120Hz)	±5% (Imax-Imin)/(Imax+Imin)
	PstLM	≤1
	SVM	≤0.4
	Current Accuracy	±5%
	Started Delay Time	≤0.5S (230VAC,full load)
Protection	Short Circuit Protection	Auto Recovery
	Overload Protection	Auto Recovery
	No-load Protection	Auto Recovery
	Insulation voltage	I/P to O/P , 3.75KVac/1min
	Ta/Operation Temperature	-20....+45℃
Environment	Ts/Storage Temperature	-40....+85℃
	Tc/Enclosure Temperature	85 ℃
	Humidity	10%....90%RH
	Atmosphere	86-108KPa
	Connection Method	Push-in Terminal
Construction	Installation	Independent & Built in
	PRI Wire preparation	0.75-1.5 [□]
	SEC Wire preparation	0.5-1.5 [□]
	Dimension	Independent:137.6*44*30mm (L*W*H) Built in:97.8*44*30mm(L*W*H)
	Certification	complied to CE ENEC SAA
Standards	Safety Standards	EN61347-1:2015, EN61347-2-13:2014/A1:2017 EN62384:2006/A1:2009 , AS61347.2.13:2018, AS/NZS61347.1:2016 Inc A1
	EMC Standards	EN IEC55015:2019, EN IEC55015:2019/A11:2019, EN IEC61000-3-2:2019, EN 61000-3-3:2013/A1:2019,EN61547:2009
	Performance	EN62384
	Surge	L-N/1KV
	RoHS	complied to 2011/65/EU
	Others	Life Time
	Warranty	5years , F.R. < 10000ppm
	Noise	≤ 28dB @Background noise ≤18dB , Interval≥15cm
<p>Remark: 1. Specific instructions are not all parameters are not connect dimmer input voltage 230 vac / 50 Hz and 25 ℃ ambient temperature measured.</p> <p>2. LED Driver is a component of the luminaires, Luminaires and wire layout will affect the EMC, please check the EMC with end products again.</p> <p>3. Leading edge & trailing edge dimmable.</p>		

2. Trailing Edge Dimmer list approved by KGP



Manufacturer	Model	Q'ty of parallel connection
ABB	6519 U	12
ABB	6526 U	13
JUNG	1224 LED UDE	11
Berker	2861	12
JUNG	254 UDIE 1	13
JUNG	225 TDE	13
EGANT	U321V2	12
Schneider	SBD200LED	13
Schneider	SBD315RC	12
Berker	2874	13
Eetako	EUD61NP-230V	12
Eetako	DTD55L-230Vwg	5
GIRA	Universal-LED-Dimmer Mini2440 00	10
EHMANN	LED-Dimmer T46.08	10
JUNG	DrehDimmer Unversal LED1731DD	10

Leading Edge Dimmer list only on request -/ or confirmed by KGP Electronics

3. Connected quantities of different current Breaker

TYPE	Connected quantities of different current Breaker						Input Voltage	Inrush Current	Time
	current (A)	10	13	16	20	25			
	Installation wire diameter	1.5mm ²	2.5mm ²	2.5mm ²	4mm ²	4mm ²			
TYPE B		20	26	32	40	50	@230VAC	30	500us
TYPE C		32	42	51	64	80			
TYPE D		51	67	82	102	128			

4. Label

KGP LED Dimmable Driver
KGP Electronics GmbH
 Hueckstraße 19
 DE-58511 Lüdenscheid

CC30W500-700CG Triac R,C

Constant Current Type For LED modules only

$U_N = 220-240V_{ac}$ 50/60Hz $\lambda: \geq 0.92C$
 $U_{out} = \text{Max. } 55V_{dc}$ SELV

PIN1	PIN2	I_o (mA)	P_o (W)	U_{out} (V)	I_r (A)
OFF	OFF	500	21	26-42	0.13
OFF	ON	550	23.1		
ON	OFF	600	25.2	26-42	0.16
ON	ON	700	29.4		

8mm
PRI 0.75-1.5
SECO. 5-1.5
 $t_c = 85^\circ C$
 $t_a = -20^\circ C - +45^\circ C$

EAC







KGP LED Dimmable Driver
KGP Electronics GmbH
 Hueckstraße 19
 DE-58511 Lüdenscheid

CC30W700-900CG Triac R,C

Constant Current Type For LED modules only

$U_N = 220-240V_{ac}$ 50/60Hz $\lambda: \geq 0.92C$
 $U_{out} = \text{Max. } 43V_{dc}$ SELV

PIN1	PIN2	I_o (mA)	P_o (W)	U_{out} (V)	I_r (A)
OFF	OFF	700	19.6	16-28	0.13
OFF	ON	800	22.4		
ON	OFF	850	23.8	16-28	0.16
ON	ON	900	25.2		

8mm
PRI 0.75-1.5
SECO. 5-1.5
 $t_c = 85^\circ C$
 $t_a = -20^\circ C - +45^\circ C$

EAC



5. Dimming curve

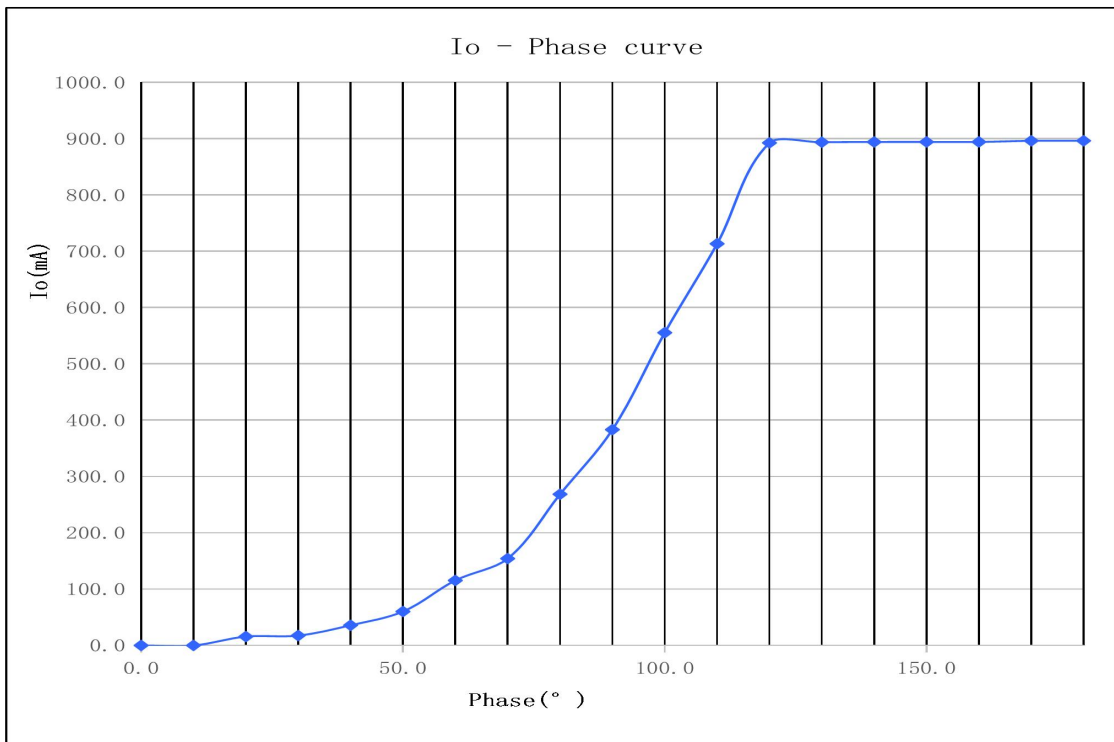

6. Lifetime curve

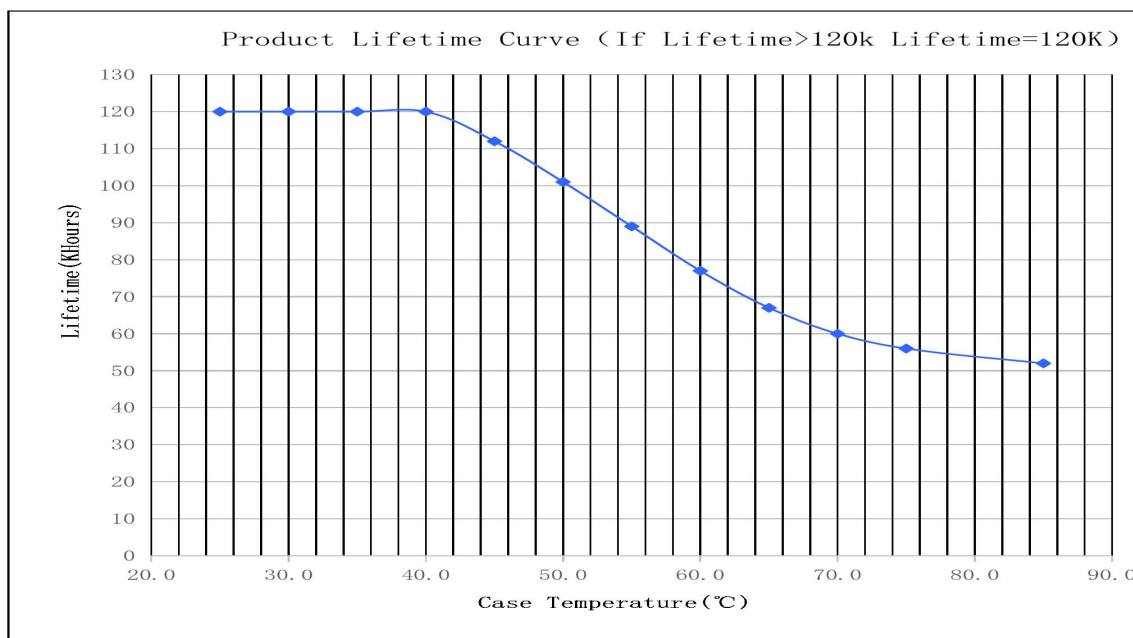

7. Dimension (Unit: mm)

Independent type:

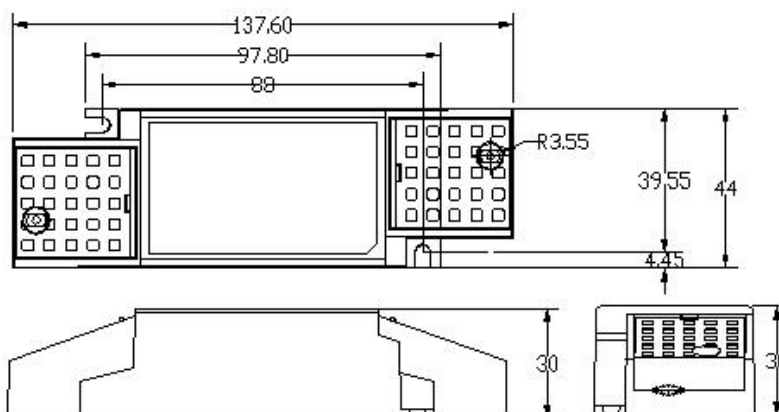

Built in type:

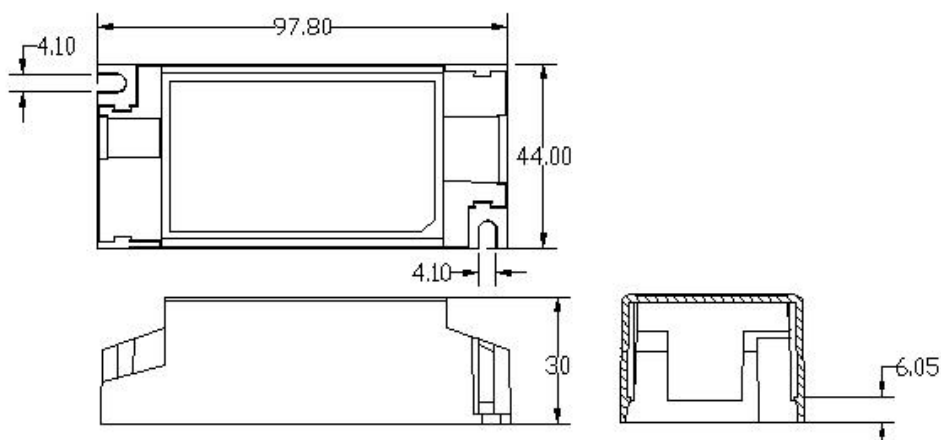

8. Packing information

Carton L*W*H(mm)	Pcs/Carton	Net weight/ Pcs(kg)	Net weight/ Carton(kg)	Gross weight / Carton(kg)
450*240*200	70	0.127	8.89	10.54

9. Wiring Diagram

Independent type:

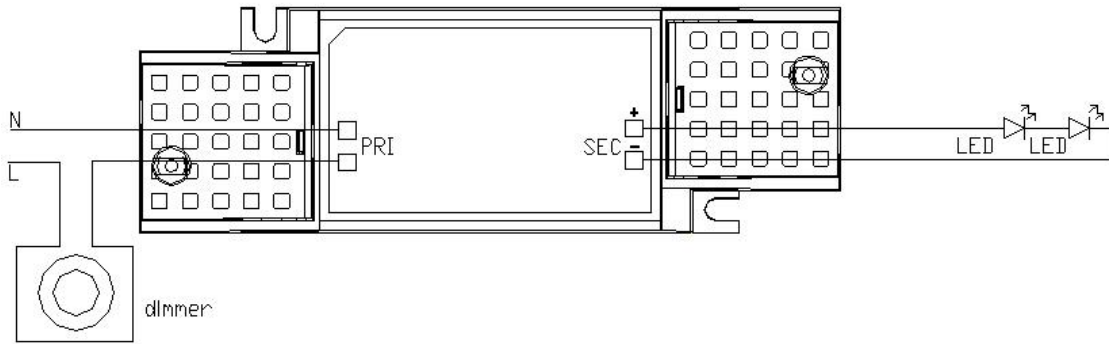

Built in type:

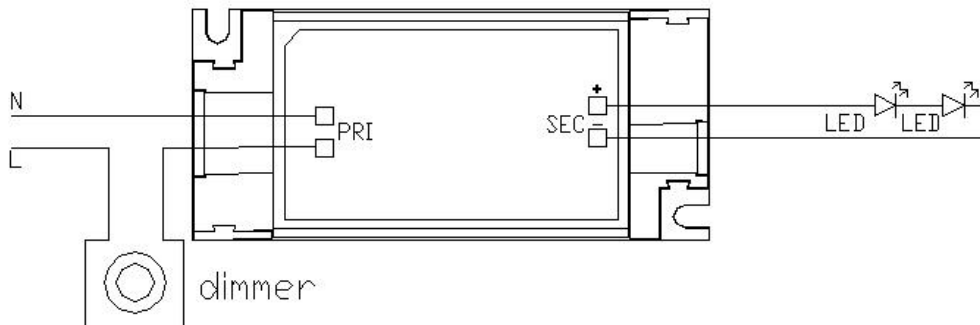

10. Wiring instructions

- All connections must be kept as short as possible to ensure good EMI behaviour
- Mains leads should be kept apart from LED Driver and other leads (ideally 5 – 10 cm distance)
- Advice the maximum length of output wires is 3 m
- Secondary switching is not permitted (Except for constant voltage)
- Incorrect wiring can damage LED modules.
- The wiring must be protected against short circuits to earth (sharp edged metals parts, metal cable clips, louver, etc.)