

Quantum

LED Quantum light body

Registered patent



Quantum masks



Quantum is a new range of recessed lighting fittings for outdoors planned to contain very efficient power leds. A new innovative concept offering significant options.

Small size: the light body, small and shallow, as result of a careful design of miniature shape, contains a well dimensioned thermic heat sink and the transformer 220-250 V / 12V. It allows to install Quantum in a normal and easy 220-250V power line. The backboxes are small and shallow as well.

Maximum modularity: you can achieve the final look covering the light body with a wide range of masks in polycarbonate, aluminium different colors, or in matt finish stainless steel 316 L. The new masks in glass make Quantum more decorative and elegant.

Different angle beam available: the light body shapes offer many types of lighting distributions and permit to choose the best light for your environment.

Power led performance: this range utilizes very efficient leds, especially dedicated to the habitat areas: very good color rendering index (85), 3,2 and 4,2 W for 410 lumen, and 50.000 h life.

Small and elegant garden posts complete the range. A first light is directed towards down to give light on the walkway plane and an second optional light in the opposite side can enlarge the lighting area in the other side of the post.

LED Quantum posts





goccia
ILLUMINAZIONE



Quantum. New recessed lighting technology.

Easy and practical to install: the light body can be dressed by different types of Masks.

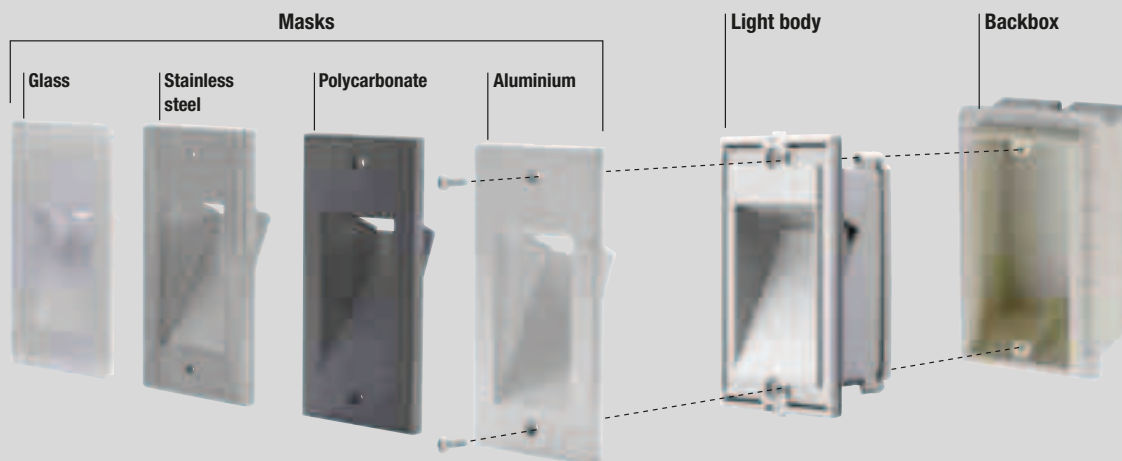

Six light bodies in different shapes, driver 220-240V inside, **can be connected to the normal 220-240V power line** (or 12V on request). Complete the lighting fitting and dress the body with Masks in the material you'll think right: the precious stainless steel 316 L, the aluminium in three different colors, the more economical polycarbonate or precious glass.

The right light.

The inclined light shapes are made to push the light towards the ground: not to lose any lumen and to avoid any dazzling. The vertical versions distribute forward the light, the horizontal versions enlarge the angle beam and allow to increase the spacing between two lamps.

Power led efficiency.

Last generation power led. Be sure the light will be enough.

Watt	Lumen	Tonality	CRI - Color rendering index
1	105	3500K	85
3,2	265	3500K	85
4,2	410	3500K	85

Photobiologic safety: risk group 0 standard EN 62471:08.





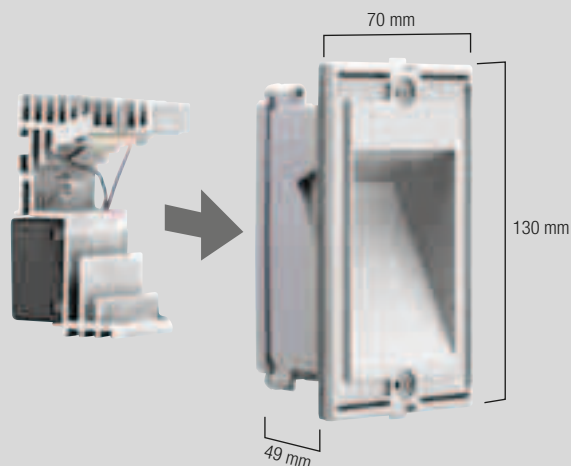
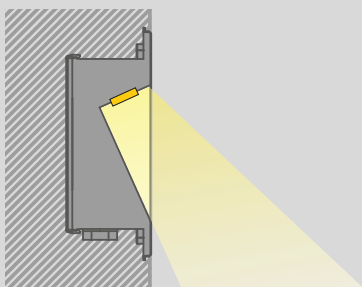







Small sizes: a great asset.

Inside a powerful heat sink keeps the temperature in the correct limit and the 220V-250V / 12V transformer allows to use a normal power line. 49 mm only inside in the wall.



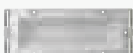

Maximum modularity: a good match for the right choice.

Light bodies	Backboxes	Masks							Materials	
										
1 W 	4 MOD.	■							Polycarbonate	
		■							Aluminium	
		■							Stainless steel	
		■							Glass	
3,2 W 	4 MOD.	■							Polycarbonate	
		■							Aluminium	
		■							Stainless steel	
		■							Glass	
1 W 	3 MOD.		■						Polycarbonate	
									Aluminium	
									Stainless steel	
			■						Glass	
3,2 W 	4 MOD.			■					Polycarbonate	
					■				Aluminium	
						■			Stainless steel	
							■		Glass	
4,2 W 	6 MOD.					■			Polycarbonate	
							■		Aluminium	
								■	Stainless steel	
									■	Glass
4,2 W 	6 MOD.						■		Polycarbonate	
								■	■	Aluminium
								■	■	Stainless steel
										■

The garden post. Elegant and flexible.

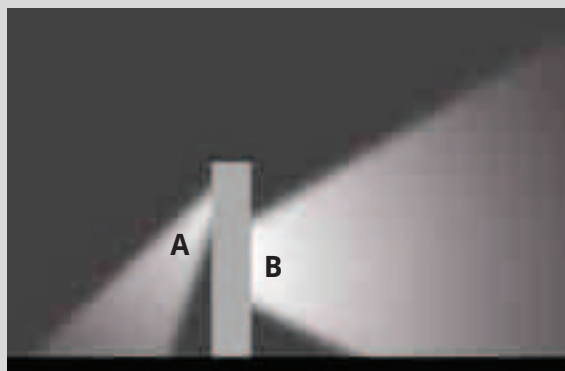

The range Quantum is complete with a small and elegant garden post in aluminium or matt stainless steel 316 L. Thanks to the body 5421 or 5425 the basic light is downwards to illuminate on your walkway, but on the opposite side is possible an optional second light directed forward. A new garden post in aluminium allows to drive the light towards the ground to avoid any dazzling.





- Body in polycarbonate
- Stainless steel screws
- To be installed on the backbox cod. 5481
- Photobiologic safety: risk group 0 standard EN 62471:08
- Led 1 W incorporated
- 105 lumen
- Warm tonality 3.500K / CRI color rendering index 85
- Life: 70% guaranteed after 50.000 h / progressive reduction until a max of 100.000 h
- 220-250V power / 350 mA - 12V incorporated
- IP 65 with 5481 - Class II double insulation
- Made according to EN 60598-1:08+A11:09 European standards C €

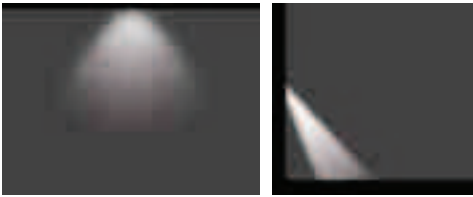
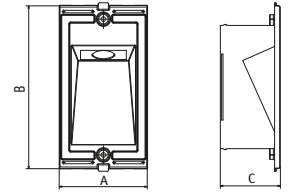

CODE NO.	Lamp	W	Lumen	A	B	C
5421	□ Led	1	105	70	130	49

12V version on request. IP65 range is guaranteed if installed with Goccia backbox code 5481. Other tonality on request.



- Body in polycarbonate
- Stainless steel screws
- To be installed on the backbox cod. 5481
- Photobiologic safety: risk group 0 standard EN 62471:08
- Led Citizen 3,2 W incorporated
- 265 lumen totally
- Warm tonality 3.500K / CRI color rendering index 85
- Life: 70% guaranteed after 50.000 h / progressive reduction until a max of 100.000 h
- 220-250V power / 350 mA - 12V incorporated
- IP 65 with 5481 - Class II double insulation
- Made according to EN 60598-1:08+A11:09 European standards C €

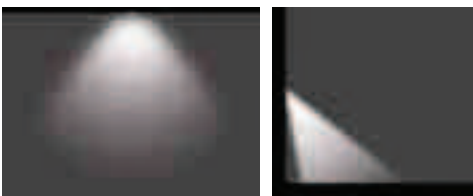
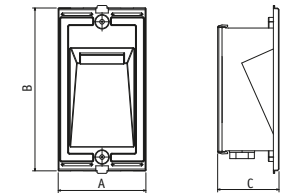

CODE NO.	Lamp	W	Lumen	A	B	C
5425	□ Led	3,2	265	70	130	49

12V version on request. Dimmable version on request. IP65 range is guaranteed if installed with Goccia backbox code 5481. Other tonality on request.



- Body in polycarbonate
- Stainless steel screws
- To be installed on the backbox cod. 5480
- Photobiologic safety: risk group 0 standard EN 62471:08
- Led Citizen 1 W incorporated
- 105 lumen
- Warm tonality 3.500K / CRI color rendering index 85
- Life: 70% guaranteed after 50.000 h / progressive reduction until a max of 100.000 h
- 220-250V power / 350 mA - 12V incorporated
- IP 65 with 5480 - Class II double insulation
- Made according to EN 60598-1:08+A11:09 European standards C €

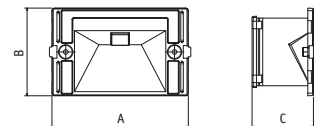

CODE NO.	Lamp	W	Lumen	A	B	C
5420	□ Led	1	105	109	70	49

12V version on request. IP65 range is guaranteed if installed with Goccia backbox code 5480. Other tonality on request.

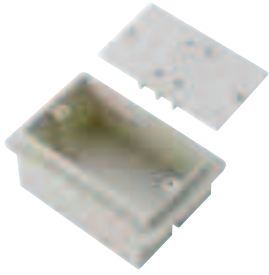

- Backbox in technopolimer
- Cover included

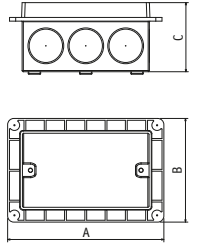

CODE NO.	Description	A	B	C
5480	Backbox for body 5420	122	84	56

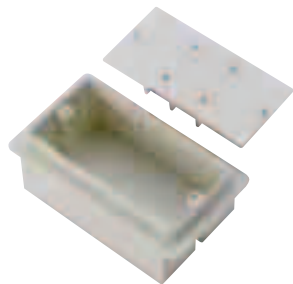

- Backbox in technopolimer
- Cover included

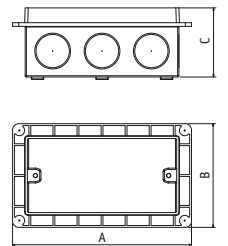

CODE NO.	Description	A	B	C
5481	Backbox for bodies 5421-5425-5430	145	84	56

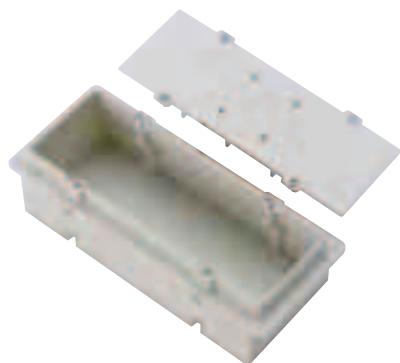

- Backbox in technopolimer
- Cover included

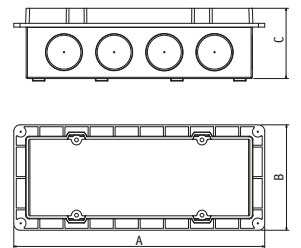

CODE NO.	Description	A	B	C
5482	Backbox for bodies 5435-5440	200	84	56

Quantum dichroic filters



- Lighting filters

Colours **AR** **VE** **BL**

CODE NO.	Description
5483 *	Dichroic filter for bodies 5420
5484 *	Dichroic filter for bodies 5421-5425
5485 *	Dichroic filter for bodies 5430
5486 *	Dichroic filter for bodies 5435
5487 *	Dichroic filter for bodies 5440



- Covering masks in polycarbonate
- Snap fastener + security screws

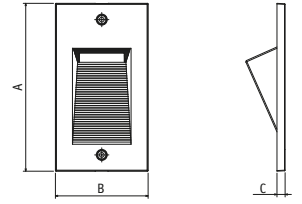

Colours **GR**

CODE NO.	Description	A	B	C
5452 *	Mask for 5421 and 5425	134	74	6,5

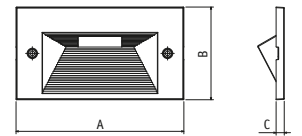

CODE NO.	Description	A	B	C
5453 *	Mask for 5430	134	74	6,5

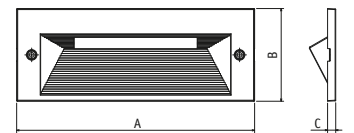

CODE NO.	Description	A	B	C
5454 *	Mask for 5435	190	74	6,5

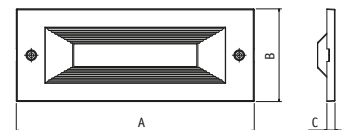

CODE NO.	Description	A	B	C
5455 *	Mask for 5440	190	74	6,5

- Covering masks in die-cast aluminium
- Snap fastener + security screws
- Pre-phosphochromed UV resistant painting
- Corten colour available upon request

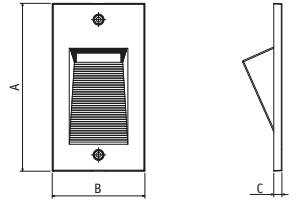

Colours **GR** **GM** **BI**

CODE NO.	Description	A	B	C
5462 *	Mask for bodies 5421 and 5425	134	74	6,5

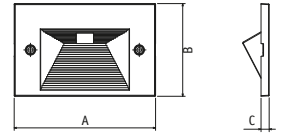

CODE NO.	Description	A	B	C
5460 *	Mask for body 5420	109	74	6,5

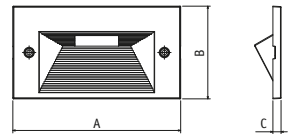

CODE NO.	Description	A	B	C
5463 *	Mask for body 5430	134	74	6,5

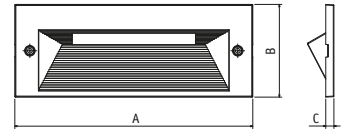

CODE NO.	Description	A	B	C
5464 *	Mask for body 5435	190	74	6,5

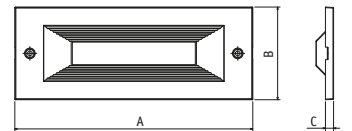

CODE NO.	Description	A	B	C
5465 *	Mask for body 5440	190	74	6,5



CODE NO.	Description	A	B	C
5466 *	Mask for body 5440	74	190	6,5

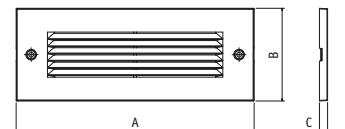
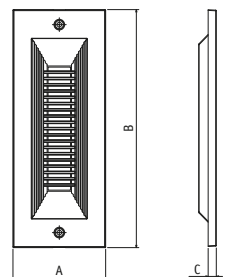

CODE NO.	Description	A	B	C
5467 *	Mask for body 5440	190	74	6,5

- Covering masks in stainless steel 316 L
- Snap fastener + security screws
- Brushed and satin matt surface

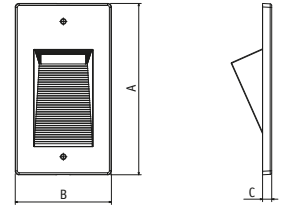

Colours **IN**

CODE NO.	Description	A	B	C
5472 *	Mask for bodies 5421 and 5425	137	77	7,5

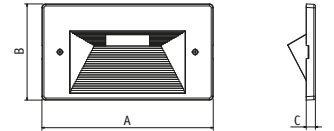

CODE NO.	Description	A	B	C
5473 *	Mask for body 5430	137	77	7,5

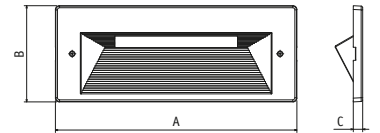

CODE NO.	Description	A	B	C
5474 *	Mask for body 5435	193	77	7,5

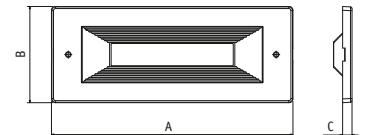

CODE NO.	Description	A	B	C
5475 *	Mask for body 5440	193	77	7,5

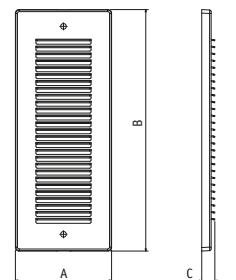

CODE NO.	Description	A	B	C
5476 *	Mask for body 5440	77	193	10,5

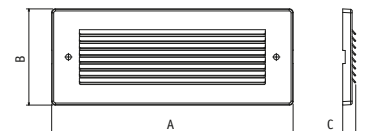

CODE NO.	Description	A	B	C
5477 *	Mask for body 5440	193	77	10,5



- Covering masks in flat tempered glass
- Snap fastener - no security screws
- Opal finish on the glass and inclined plan in white

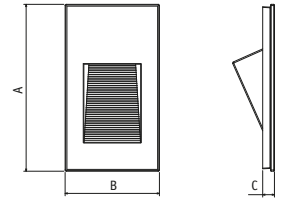

Colours **OP**

CODE NO.	Description	A	B	C
5441 *	Mask for bodies 5421 and 5425	138	78	10

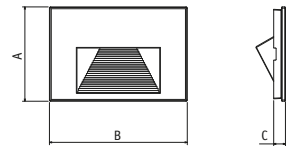

CODE NO.	Description	A	B	C
5442 *	Mask for body 5420	78	114	10

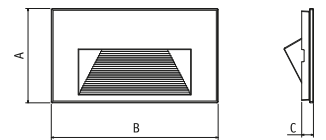

CODE NO.	Description	A	B	C
5443 *	Mask for body 5430	78	138	10

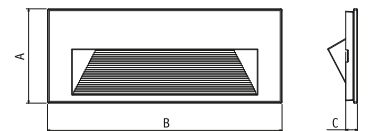

CODE NO.	Description	A	B	C
5444 *	Mask for body 5435	78	194	9,7



Quantum external box aluminium

goccia
ILLUMINAZIONE

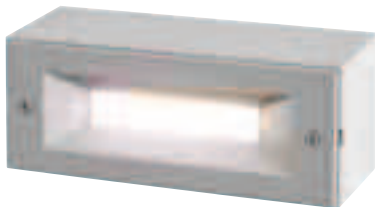

- Aluminium body
- Made to contain body 5430, 5435 or 5440 and its masks
- Rear or side cable entry
- Through wiring allowed
- Terminal block incorporated
- Suitable to 14 mm \varnothing wiring
- Pre-phosphochrome + UV resistant coating
- Made according to EN 60439-1 European standards $\text{C}\ \text{€}$

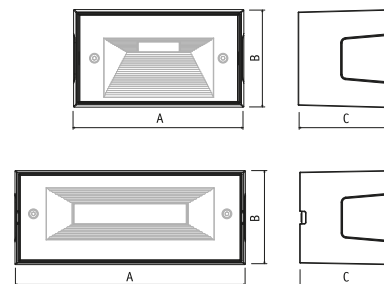

Colours **GR** **GM**

CODE NO.	Description	A	B	C
5411 *	Box for body 5430	143	82	76
5412 *	Box for bodies 5435 and 5440	197,65	80,65	76

Box only. Quantum fitting supplied separately.

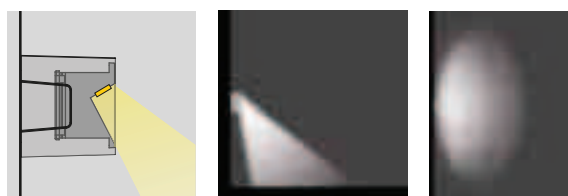

Box + 5430-5435 downwards oriented.



Box + 5440 outwards oriented.

Quantum wall washer box aluminium

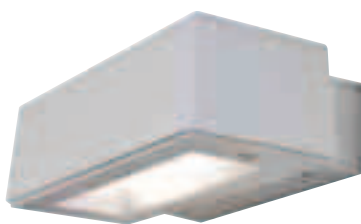

- Aluminium body
- Made to contain body 5430, 5435 or 5440 and its masks
- The body 5435 can be outwards or wallwards oriented
- Rear or side cable entry
- Through wiring allowed
- Terminal block incorporated
- Suitable to 12 mm \varnothing wiring
- Pre-phosphochrome + UV resistant coating
- Made according to EN 60439-1 European standards $\text{C}\ \text{€}$

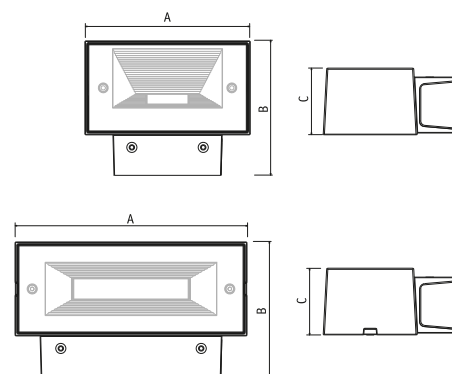

Colours **GR** **GM**

CODE NO.	Description	A	B	C
5415 *	Box for body 5430	138,89	112,95	56
5416 *	Box for bodies 5435 and 5440	194,89	112,95	56

Box only. Quantum fitting supplied separately.

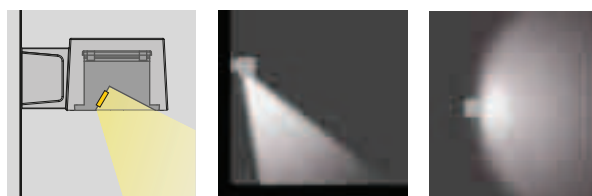

Box + 5430-5435 outwards/wallwards oriented.

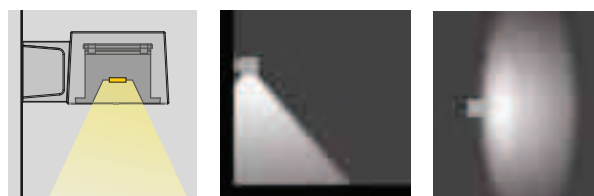

Box + 5440 downwards oriented.

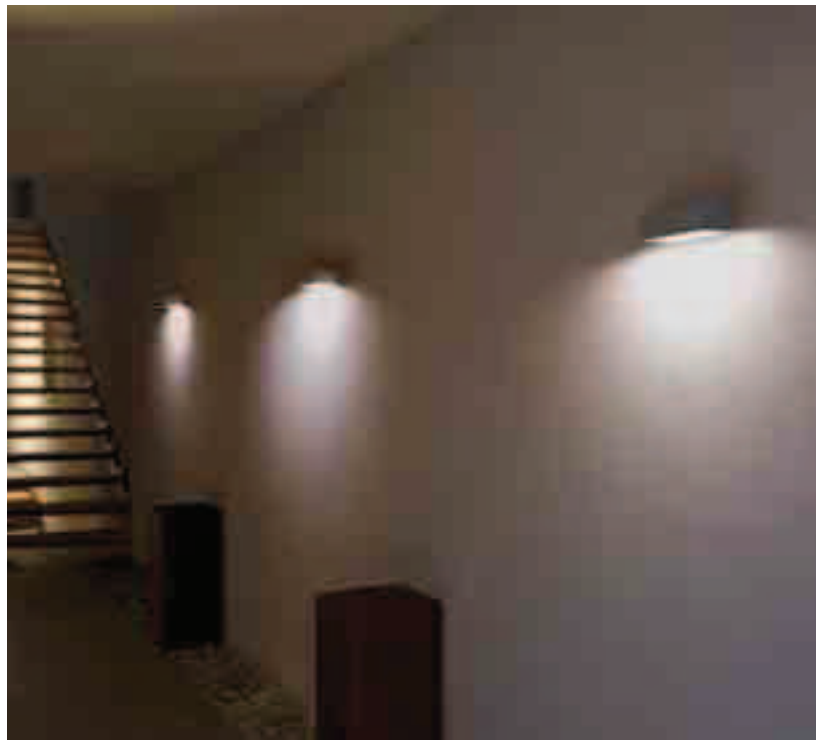

Only one light point will generate all the lights you need

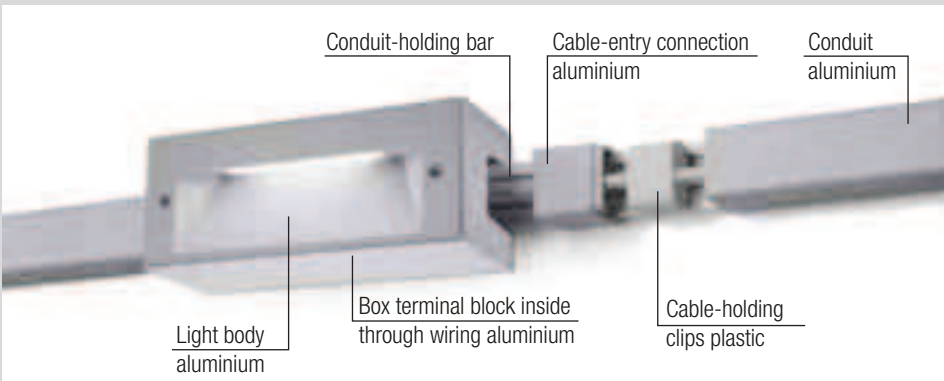

The vandal-proof cable trunking, completely in aluminium, allows to give power to many lights starting from only one light point. Suitable to hold the external or the wall-washer boxes. In this way you can bring the light where you cannot recess a backbox or where the wall already is existing.

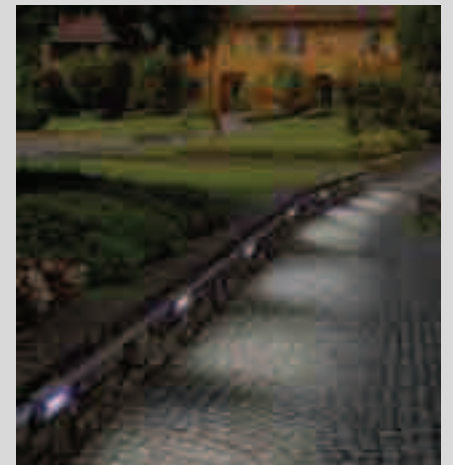

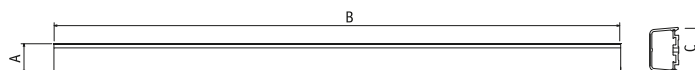
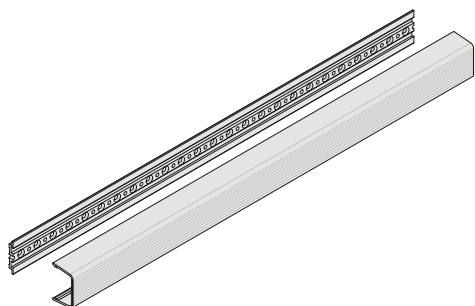

- Holding bar in extruded aluminium
- Vandal proof aluminium conduit
- Bar + conduit suitable to be cut
- 10 cable-holding clips inside
- Snapping connection bar/conduit
- IK10 (20 joules) impact test
- Pre-phosphochrome + UV resistant coating
- Made according to EN 60439-1 European standards C €

Colours **GR** **GM**

CODE NO.	Description	A	B	C
5401 *	Bar + conduit	25,5	2000	39,92

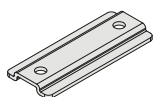

Connection bracket

- Steel bracket to connect two conduits
- Made in unpainted steel

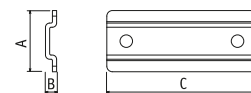

CODE NO.	Description	A	B	C
5402	Connection bracket	22	4	54

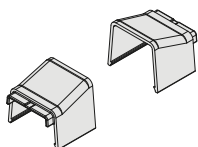

Cable entry connection

- Pair of connections in aluminium
- To cover cable entry

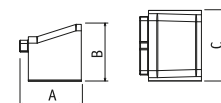

Colours **GR** **GM**

CODE NO.	Description	A	B	C
5405 *	Connection pair for 5411-5412	35	40,13	39,92
5406 *	Connection pair for 5415-5416	35	32,13	39,92

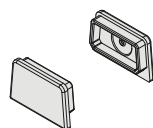

Side cap

- Rubber side cap

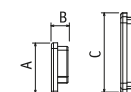



CODE NO.	Description	A	B	C
5407	Side cap	24,5	8	38,8

Quantum aluminium post

goccia
ILLUMINAZIONE

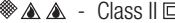

- Structure, base and top in aluminium
- Complete with Led 3,2W / 3500K / CRI 85 / 265 lumen + mask 5462
- Option to insert on the back the body 5440 and the mask 5465 or 5466
- Driver 230V inside
- Connection box inside
- Photobiologic safety: risk group 0 standard EN 62471:08
- Pre-phosphochrome + UV resistant coating
- Corten colour available upon request
- IP 65  - Class II 
- Made according to EN 60439-1 European standards 

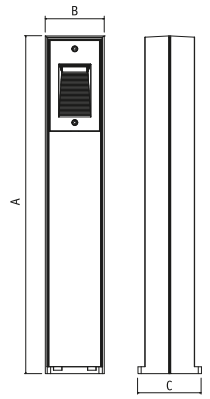



Colours **GR** **GM**

CODE NO.	Lamp	W	Lumen	A	B	C
5591 *	 Led	3,2	265	495	86,5	93

Complete with Led body in front.

Quantum stainless steel post



- Structure in stainless steel 316 L
- Complete with Led 3,2W / 3500K / CRI 85 / 265 lumen + mask 5472
- Option to insert on the back the body 5440 and the mask 5475 or 5476
- Driver 230V inside
- Connection box inside
- Photobiologic safety: risk group 0 standard EN 62471:08
- Brushed and satin matt surface
- IP 65  - Class II 
- Made according to EN 60439-1 European standards 

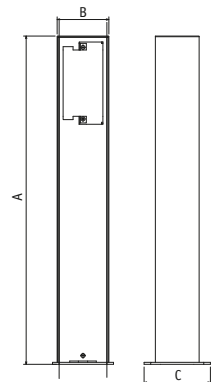

Colours **IN**

CODE NO.	Lamp	W	Lumen	A	B	C
5592 *	 Led	3,2	265	495	66	100

Complete with Led body in front.

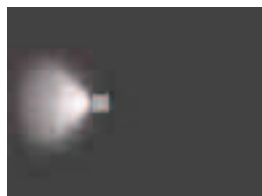

Quantum post. One light.



Quantum post. Two lights.

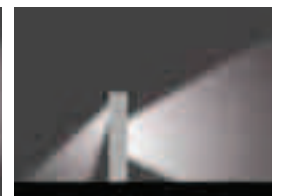

Quantum plate with anchoring set



- Stainless steel plate with ground anchoring set
- To be installed with codes 5591 - 5592

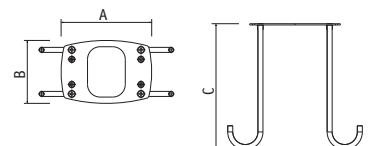

CODE NO.	Description	A	B	C
5496	Plate with anchoring set	92	77	200

Energy class: go to code index



Quantum aluminium post



- Structure, base and top in aluminium
- Complete with Led 10W / 3500K / CRI 85 / 1040 lumen + mask
- Driver 230V inside
- Connection box inside
- Photobiologic safety: risk group 0 standard EN 62471:08
- Pre-phosphochrome + UV resistant coating
- Corten colour available upon request
- IP 65 - Class II
- Made according to EN 60439-1 European standards

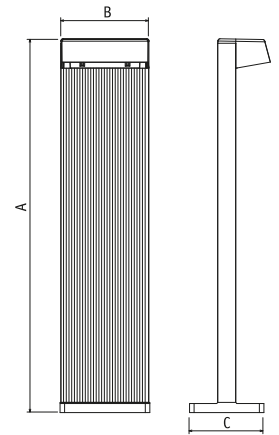

Colours **GR** **GM**



CODE NO.	Lamp	W	Lumen	A	B	C
5593 *	Led	10	1040	825	194	164
5594 *	Led	10	1040	530	194	164

Complete with 10W Led. Driver 230V inside.

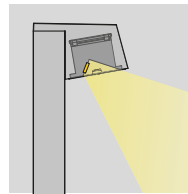

Quantum plate with anchoring set



- Stainless steel plate with ground anchoring set
- To be installed with codes 5593-5594

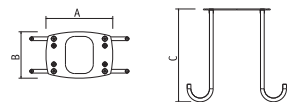

CODE NO.	Description	A	B	C
5497	Plate with anchoring set	195	160	200



Quantum small garden post

goccia
ILLUMINAZIONE

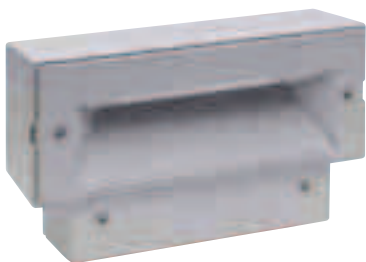

- Structure totally in aluminium
- Complete with Led 3,2W (5595) and 4,2W (5596). Mask included
- Side and bottom cable entry
- CRI 85 / 3500K
- Driver 230V inside
- Through wiring allowed
- Pre-phosphochrome + UV resistant coating
- Corten colour available upon request
- IP 65 - Class II
- Made according to EN 60439-1 European standards

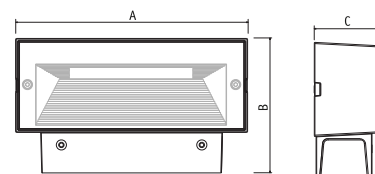

Colours

CODE NO.	Lamp	W	Lumen	A	B	C
5595 *	Led	3,2	265	139	110	56
5596 *	Led	4,2	410	195	110	56

Complete with Led unit 3,2W (5595) and 4,2W (5596).



Quantum small garden post



- Structure totally in aluminium
- Complete with Led 4,2W. Mask included
- Side and bottom cable entry
- CRI 85 / 3500K
- Driver 230V inside
- Through wiring allowed
- Pre-phosphochrome + UV resistant coating
- Corten colour available upon request
- IP 65 - Class II
- Made according to EN 60439-1 European standards

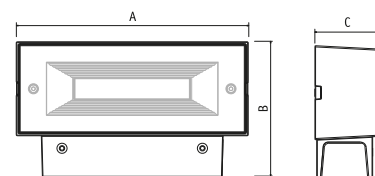

Colours

CODE NO.	Lamp	W	Lumen	A	B	C
5598 *	Led	4,2	410	195	110	56

Complete with Led unit 4,2W.



