



P85034



P81819

P81828

**Description**

DMT is a smoothly shaped mini-trunking range providing quick and easy concealed installation of cables and wiring for power and low voltage.

DMT mini-trunking, made up by a base profile and a snap-fitted cover, is available in three materials; aluminium, lead and cadmium-free PVC or halogen-free PC/ABS. Accessories, like corner and end pieces, are made of halogen-free PC/ABS.

The PVC and PC/ABS trunking are approved for single-insulated cable if non-metallic fasteners are used. One, two, and three-compartment trunking can be combined by using a branching piece.

The sizes 1220 and 1820 are also available with bonding tape on the back of the base profile. Note however that if only bonding tape is used to fix the trunking to the wall, these two types are not approved for power cabling.

Both cover and base profile are U-shaped and therefore stable during handling. The base profile is provided with pre-punched holes to facilitate mounting on the wall. The cover cannot be removed without a tool.

**Benefits**

- Wide range – six sizes and 17 variants
- Impact-resistant and tamper-proof. Can only be opened with tools.
- Smooth design
- U-shaped profiles – easy to handle
- Pre-punched holes – easy to install
- IP40 protection. Plastic trunking classified for single-insulated wires.
- Can be used both indoors and outdoors
- Branching piece – easy to combine different sizes
- Partition walls can be removed to allow space for larger cables
- Environment-friendly – no heavy metals, halogen-free alternatives

**Technical and Material data**

Aluminium (base, cover)	Surface treatment:	Natural anodized or powder coated white NCS 0502-Y81R
	Density:	2.7 g/cm <sup>3</sup>
	Linear expansion:	24x10 <sup>-6</sup> /°C
PVC (base, cover)	Characteristics:	Rigid, self-extinguishing, cadmium-free, lead-free
	Colours:	White RAL 9010 White RAL 9016
	Density:	1.5 g/cm <sup>3</sup>
	Linear expansion:	60x10 <sup>-6</sup> /°C
PC/ABS (base, cover, accessories)	Characteristics:	Halogen-free
	Colours:	White RAL 9010 White RAL 9016 Light grey (alu metallic)
	Density:	1.14 g/cm <sup>3</sup>
	Linear expansion:	70x10 <sup>-6</sup> /°C
ABS (fly-over)	Characteristics:	Halogen-free
	Colour:	White
	Density:	1.05 g/cm <sup>3</sup>
Degree of protection	IP40	
Temperature range	Plastic trunking: -15/+60°C (DMT-1220 and 1820) -25/+60°C (DMT-1230, 1835, 1845 and 2560)	
Resistance to impact	Plastic trunking: • 1J (DMT-1220 and 1820) • 2J (DMT-1230, 1835, 1845 and 2560)	
Delivery lengths	• Aluminium trunking 2.5 metres • Plastic trunking 2 metres	
Standards and certificates	The product complies with the standards: • EN 50085-1:1997 and A1 • prEN 50085-2-1:2002 • SS 424 10 32:1989 The certificate expires May 16th, 2010. The products also satisfy the provisions for CE marking according to the Low Voltage Directive 73/23/EEC and 98/68/EEC.	

**Exploded view**

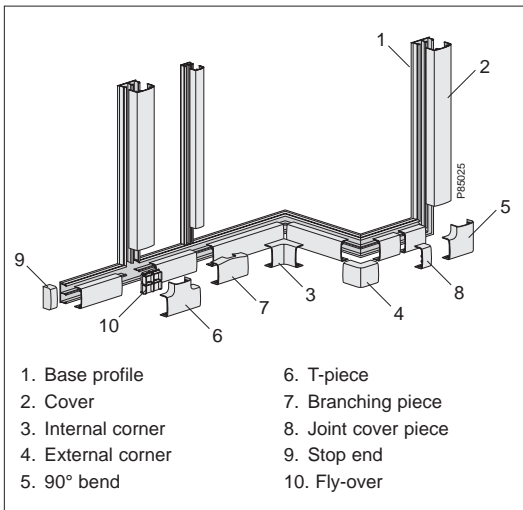

Design and dimensions

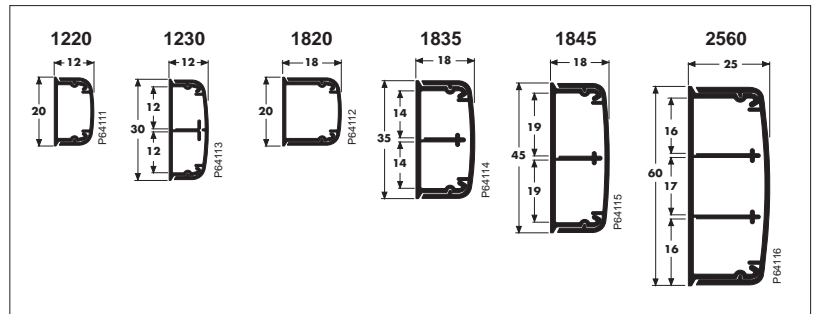

Cable capacity

Comp.	Max. cable Ø mm	Cross section area mm <sup>2</sup>	Cable capacity mm <sup>2</sup>			
			40%	50%	60%	
<b>1220</b>						
1	10	148	59	74	89	
<b>1820</b>						
1	15	246	98	123	148	
<b>1230</b>						
1	9	115	46	57	69	
2	9	115	46	57	69	
<b>1835</b>						
1	12.5	201	80	100	120	
2	12.5	201	80	100	120	
<b>1845</b>						
1	14	278	111	139	167	
2	14	278	111	139	167	
<b>2560</b>						
1	15	339	135	170	203	
2	17	389	135	170	203	
3	15	339	135	170	203	

DMT Mini-trunking

Type	Colour	Dimensions A/B/C (mm)		Qty per package	EAN code	Internal ID-No.	Ref. No.
------	--------	-----------------------	---	-----------------	----------	-----------------	----------

**Aluminium mini-trunking**

Mini-trunking including base profile with one or two compartments and snap-fitted cover. With pre-punched mounting holes at 400 mm centres. Suitable for power and low voltage cables. Supplied in 2.5 m lengths. Material: Aluminium, natural anodized or powder coated white.



PE3318

<b>DMT-A-1220</b> With one compartment	Natural White NCS	20/12/2500		25 m	7315885432109 7315880111641	20046903 20048636	5432 100 5432 108
---	----------------------	------------	--	------	--------------------------------	----------------------	----------------------



PE3319

<b>DMT-A-1820</b> With one compartment	Natural White NCS	20/18/2500		25 m	7315885432116 7315880111658	20046902 20048637	5432 110 5432 118
---	----------------------	------------	--	------	--------------------------------	----------------------	----------------------



PE3320

<b>DMT-A-1835</b> With two compartments	Natural White NCS	35/18/2500		25 m	7315885432123 7315880111665	20046904 20048638	5432 120 5432 128
--	----------------------	------------	--	------	--------------------------------	----------------------	----------------------

**PVC mini-trunking**

Mini-trunking including base profile with one, two or three compartments, and snap-fitted cover. Partition walls can be removed. With pre-punched mounting holes at 100 mm centres. Suitable for power and low voltage cables. Approved for single-insulated cable if non-metallic fastener is used. Supplied in 2 m lengths. Material: PVC.



PE3321

<b>DMT-1220</b> With one compartment	White RAL 9010 White RAL 9016	20/12/2000		40 m	7315885400207 7315880111573	20048184 20048185	5400 200 5400 202
---	----------------------------------	------------	--	------	--------------------------------	----------------------	----------------------



PE3322

<b>DMT-1820</b> With one compartment	White RAL 9010 White RAL 9016	20/18/2000		40 m	7315885400221 7315880111597	20048188 20048189	5400 220 5400 222
---	----------------------------------	------------	--	------	--------------------------------	----------------------	----------------------



PE3323

<b>DMT-1230</b> With two compartments	White RAL 9010 White RAL 9016	30/12/2000		40 m	7315885400214 7315880111580	20048186 20048187	5400 210 5400 212
--	----------------------------------	------------	--	------	--------------------------------	----------------------	----------------------



PE3324

<b>DMT-1835</b> With two compartments	White RAL 9010 White RAL 9016	35/18/2000		40 m	7315885400238 7315880111603	20048190 20048191	5400 230 5400 232
--	----------------------------------	------------	--	------	--------------------------------	----------------------	----------------------



PE3325

<b>DMT-1845</b> With two compartments	White RAL 9010 White RAL 9016	45/18/2000		40 m	7315885400245 7315880111610	20048192 20048193	5400 240 5400 242
--	----------------------------------	------------	--	------	--------------------------------	----------------------	----------------------



PE3326

<b>DMT-2560</b> With three compartments	White RAL 9010 White RAL 9016	60/25/2000		20 m	7315885400252 7315880111627	20048194 20048195	5400 250 5400 252
--	----------------------------------	------------	--	------	--------------------------------	----------------------	----------------------

**PVC mini-trunking with bonding tape**

Mini-trunking including base profile with one compartment and snap-fitted cover. With pre-punched mounting holes at 100 mm centres. Provided with bonding tape on the back of the base profile. Not approved for power cabling if the trunking is only fixed to the wall by the tape. If the fixing by tape is combined with screw-fixing, power cables may also be installed. Approved for single-insulated cable if non-metallic fastener is used for the combined fixing. Supplied in 2 m lengths. Material: PVC.



PE3321

<b>DMT-1220BT</b>	White RAL 9010 White RAL 9016	20/12/2000		40 m	7315885432130 7315880112518	20048912 20048913	5432 130 5432 132
-------------------	----------------------------------	------------	--	------	--------------------------------	----------------------	----------------------



PE3322

<b>DMT-1820BT</b>	White RAL 9010 White RAL 9016	20/18/2000		40 m	7315885432147 7315880112525	20048914 20048915	5432 140 5432 142
-------------------	----------------------------------	------------	--	------	--------------------------------	----------------------	----------------------

DMT Mini-trunking

Type	Colour	Dimensions A/B/C (mm)		Qty per package	EAN code	Internal ID-No.	Ref. No.
------	--------	-----------------------	---	-----------------	----------	-----------------	----------

**PC/ABS (halogen-free) mini-trunking**

Mini-trunking including base profile with one, two or three compartments and snap-fitted cover. Partition walls can be removed. With pre-punched mounting holes at 100 mm centres. Suitable for power and low voltage cables. Approved for single-insulated cable if non-metallic fastener is used. Supplied in 2 m lengths.  
Material: PC/ABS.



PR3321

<b>DMT-1220</b> With one compartment	White RAL 9010	20/12/2000		40 m	7332418016988	20056115	5432 180
	White RAL 9016				7332418016995	20056116	5432 182



PR3322

<b>DMT-1820</b> With one compartment	White RAL 9010	20/18/2000		40 m	7332418017022	20056119	5432 188
	White RAL 9016				7332418017039	20056120	5432 190



PR3324

<b>DMT-1835</b> With two compartments	White RAL 9010	35/18/2000		40 m	7315885400269	20048196	5400 260
	White RAL 9016				7315880111634	20048197	5400 262



PR3326

<b>DMT-2560</b> With three compartments	White RAL 9010	60/25/2000		20 m	7315885432154	20048916	5432 150
	White RAL 9016				7315880112532	20048917	5432 152

**PC/ABS (halogen-free) mini-trunking with bonding tape**

Mini-trunking including base profile with one compartment and snap-fitted cover. Partition walls can be removed. With pre-punched mounting holes at 100 mm centres. Provided with bonding tape on the back of the base profile. Not approved for power cabling if the trunking is only fixed to the wall by the tape. If the fixing by tape is combined with screw-fixing, power cables may be installed. Approved for single-insulated cable if non-metallic fastener is used for the combined fixing. Supplied in 2 m lengths.  
Material: PC/ABS.



PR3321

<b>DMT-1220BT</b>	White RAL 9010	20/12/2000		40 m	7332418017008	20056117	5432 184
	White RAL 9016				7332418017015	20056118	5432 186



PR3322

<b>DMT-1820BT</b>	White RAL 9010	20/18/2000		40 m	7332418017046	20056121	5432 192
	White RAL 9016				7332418017053	20056122	5432 194

DMT Accessories



PR3921

Type	Colour	Dimensions A/B/C (mm)		Qty per package	EAN code	Internal ID-No.	Ref. No.
<b>Internal corner</b>							
Internal corner to be snap-fitted onto the mini-trunking base. Material: PC/ABS.							
DMT-IH1220	Light grey	20/40/40		10	7315880111702	20048257	5401 402
	White RAL 9010				7315885401402	20048258	5401 400
	White RAL 9016				7315880111696	20048259	5401 401
DMT-IH1230	White RAL 9010	32/40/40		10	7315880111719	20048260	5401 403
	White RAL 9016				7315880111726	20048261	5401 404
DMT-IH1820	Light grey	20/45/45		10	7315880111757	20048262	5401 408
	White RAL 9010				7315880111733	20048263	5401 406
	White RAL 9016				7315880111740	20048264	5401 407
DMT-IH1835	Light grey	37/45/45		10	7315880111771	20048265	5401 411
	White RAL 9010				7315880111764	20048266	5401 409
	White RAL 9016				7315885401419	20048267	5401 410
DMT-IH1845	White RAL 9010	47/45/45		10	7315880111788	20048268	5401 413
	White RAL 9016				7315880111795	20048269	5401 414
DMT-IH2560	White RAL 9010	62/53/53		10	7315880111801	20048270	5401 416
	White RAL 9016				7315880111818	20048271	5401 417



PR3922

<b>External corner</b>							
External corner to be snap-fitted onto the mini-trunking base. Material: PC/ABS.							
DMT-YH1220	Light grey	22/36/36		10	7315880112402	20048317	5401 557
	White RAL 9010				7315880112389	20048318	5401 555
	White RAL 9016				7315880112396	20048319	5401 556
DMT-YH1230	White RAL 9010	32/36/36		10	7315880112419	20048320	5401 559
	White RAL 9016				7315885401563	20048321	5401 560
DMT-YH1820	Light grey	22/42/42		10	7315880112440	20048322	5401 564
	White RAL 9010				7315880112426	20048323	5401 562
	White RAL 9016				7315880112433	20048324	5401 563
DMT-YH1835	Light grey	37/42/42		10	7315880112471	20048325	5401 568
	White RAL 9010				7315880112457	20048326	5401 566
	White RAL 9016				7315880112464	20048327	5401 567
DMT-YH1845	White RAL 9010	47/42/42		10	7315885401570	20048328	5401 570
	White RAL 9016				7315880112488	20048329	5401 571
DMT-YH2560	White RAL 9010	62/49/49		10	7315880112495	20048330	5401 574
	White RAL 9016				7315880112501	20048331	5401 575



PR3923

<b>T-piece</b>							
T-piece to be used in T-junctions between mini-trunking of the same size. To be snap-fitted onto the mini-trunking base. Material: PC/ABS.							
DMT-TS1220	Light grey	12/40/58		10	7315880111955	20048287	5401 452
	White RAL 9010				7315885401457	20048288	5401 450
	White RAL 9016				7315880111948	20048289	5401 451
DMT-TS1230	White RAL 9010	12/50/68		10	7315880112150	20048290	5401 512
	White RAL 9016				7315880112167	20048291	5401 513
DMT-TS1820	Light grey	18/40/58		10	7315880112198	20048292	5401 516
	White RAL 9010				7315880112174	20048293	5401 514
	White RAL 9016				7315880112181	20048294	5401 515
DMT-TS1835	Light grey	18/55/73		10	7315880112211	20048295	5401 522
	White RAL 9010				7315885401525	20048296	5401 520
	White RAL 9016				7315880112204	20048297	5401 521
DMT-TS1845	White RAL 9010	18/65/83		10	7315880112228	20048298	5401 525
	White RAL 9016				7315880112235	20048299	5401 526
DMT-TS2560	White RAL 9010	24/80/98		10	7315885401532	20048300	5401 530
	White RAL 9016				7315880112242	20048301	5401 531

DMT Accessories



PR3324

Type	Colour	Dimensions A/B/C (mm)	Qty per package	EAN code	Internal ID-No.	Ref. No.
<b>Bend, 90°</b>						
90 degree bend to be used in junctions between horizontal and vertical applications. To be snap-fitted onto the mini-trunking base. Material: PC/ABS.						
DMT-LS1220	Light grey	12/40/40	10	7315880111832	20048272	5401 422
	White RAL 9010			7315885401426	20048273	5401 420
	White RAL 9016			7315880111825	20048274	5401 421
DMT-LS1230	White RAL 9010	12/50/50	10	7315880111849	20048275	5401 424
	White RAL 9016			7315880111856	20048276	5401 425
DMT-LS1820	Light grey	18/40/40	10	7315880111870	20048277	5401 432
	White RAL 9010			7315885401433	20048278	5401 430
	White RAL 9016			7315880111863	20048279	5401 431
DMT-LS1835	Light grey	18/55/55	10	7315880111900	20048280	5401 437
	White RAL 9010			7315880111887	20048281	5401 435
	White RAL 9016			7315880111894	20048282	5401 436
DMT-LS1845	White RAL 9010	18/65/65	10	7315885401440	20048283	5401 440
	White RAL 9016			7315880111917	20048284	5401 441
DMT-LS2560	White RAL 9010	24/80/80	10	7315880111924	20048285	5401 443
	White RAL 9016			7315880111931	20048286	5401 444



PR3325

Type	Colour	Dimensions A/B/C (mm)	Qty per package	EAN code	Internal ID-No.	Ref. No.
<b>Stop end</b>						
Stop end to be snap-fitted at the end of the mini-trunking base. Material: PC/ABS.						
DMT-ES1220	Light grey	22/15/13	10	7315880112037	20048240	5401 474
	White RAL 9010			7315885401471	20048241	5401 472
	White RAL 9016			7315880112020	20048242	5401 473
DMT-ES1230	White RAL 9010	32/15/13	10	7315880112044	20048243	5401 476
	White RAL 9016			7315880112051	20048244	5401 477
DMT-ES1820	Light grey	22/15/19	10	7315880112075	20048245	5401 482
	White RAL 9010			7315885401488	20048246	5401 480
	White RAL 9016			7315880112068	20048247	5401 481
DMT-ES1835	Light grey	37/15/19	10	7315880112105	20048250	5401 487
	White RAL 9010			7315880112082	20048248	5401 485
	White RAL 9016			7315880112099	20048249	5401 486
DMT-ES1845	White RAL 9010	47/15/19	10	7315880112112	20048251	5401 489
	White RAL 9016			7315885401495	20048252	5401 490
DMT-ES2560	White RAL 9010	62/17/26	10	7315880112129	20048253	5401 492
	White RAL 9016			7315880112136	20048254	5401 493



PR3326

Type	Colour	Dimensions A/B/C (mm)	Qty per package	EAN code	Internal ID-No.	Ref. No.
<b>Joint cover piece</b>						
Joint cover piece to cover joints between mini-trunking covers. Material: PC/ABS.						
DMT-US1220	Light grey	22/22/13	10	7315880112273	20048302	5401 536
	White RAL 9010			7315880112259	20048303	5401 534
	White RAL 9016			7315880112266	20048304	5401 535
DMT-US1230	White RAL 9010	32/22/13	10	7315880112280	20048305	5401 538
	White RAL 9016			7315880112297	20048306	5401 539
DMT-US1820	Light grey	22/22/19	10	7315880112310	20048307	5401 543
	White RAL 9010			7315885401549	20048308	5401 541
	White RAL 9016			7315880112303	20048309	5401 542
DMT-US1835	Light grey	37/22/19	10	7315880112341	20048312	5401 547
	White RAL 9010			7315880112327	20048310	5401 545
	White RAL 9016			7315880112334	20048311	5401 546
DMT-US1845	White RAL 9010	47/22/19	10	7315880112358	20048313	5401 548
	White RAL 9016			7315880112365	20048314	5401 549
DMT-US2560	White RAL 9010	62/22/26	10	7315885401556	20048315	5401 551
	White RAL 9016			7315880112372	20048316	5401 552

**DMT Accessories**



PR3927

Type	Colour	Dimensions A/B/C (mm)		Qty per package	EAN code	Internal ID-No.	Ref. No.
<b>Branching piece</b>							
Branching piece to be used in T-junctions between mini-trunking of different sizes. Material: PC/ABS.							
DMT-AS1835/1220	Light grey	58/40/17		10	7315880111979	20048233	5401 462
	White RAL 9010				7315885401464	20048234	5401 460
	White RAL 9016				7315880111962	20048235	5401 461
DMT-AS1845/1220	White RAL 9010	64/50/17		10	7315880111986	20048236	5401 464
	White RAL 9016				7315880111993	20048237	5401 465
DMT-AS2560/1835	White RAL 9010	79/65/24		10	7315880112006	20048238	5401 468
	White RAL 9016				7315880112013	20048239	5401 469



P7777

Type	Colour	Dimensions A/B/C (mm)		Qty per package	EAN code	Internal ID-No.	Ref. No.
<b>Fly-over</b>							
Fly-over to be used in combination with T-piece or branching piece. Intended to secure separation between compartments when single-insulated cable is used. Material: ABS							
DMT-FO1835	White	13/30/30		10	7315885401518	20048255	5401 510
DMT-FO2560	White	20/55/55		10	7315880112143	20048256	5401 511

P7763

**Compatible accessories**

Products compatible with the DMT system.



PR9133

Type	Colour	Dimensions A/B/C (mm)		Qty per package	EAN code	Internal ID-No.	Ref. No.
<b>Clamp</b>							
Clamp intended to hold cables in place in the feeder trunking. Material: PA.							
TTM-KL26	Black	7.5/26/22		10	7315885401600	10002266	5401 600



PR2869

TTM-KL36	Black	9.5/36/25		10	7315885401617	10002267	5401 610
----------	-------	-----------	--	----	---------------	----------	----------









PR1380

Type	Colour	Dimensions A/B/C (mm)		Qty per package	EAN code	Internal ID-No.	Ref. No.
<b>Cutting shears</b>							
Cutting shears for PVC and PC/ABS material. To be used when cutting mini-trunking, front covers, cable shelves or other plastic length material, instead of using a saw. Material: Steel.							
ISV-CS	Orange	230/22/80		1	7332418016971	20056650	5900 065

**Fixing material**

Fixing material compatible with the DMT system.

Type	Colour	Dimensions Ø/Length (mm)	Qty per package	EAN code	Internal ID- No.	Ref. No.
<b>Screw plug</b>						
Screw plug suitable for use in concrete, stone, lightweight concrete, expanded clay, hollow blocks and bricks, solid bricks and plasterboard. Material: PE.						
 P89050	<b>TP 6x30</b>	Red	6/30	100	7315881003020	10000026 1003 020
<b>Nail plugs</b>						
Nail plug with nail for through installation. Suitable for use in concrete, stone, lightweight concrete, expanded clay, hollow blocks and bricks, solid bricks and plasterboard. Material: PA.						
 P89051	<b>TPS-4/5x25</b>	Clear	4/25	100	7315881149308	10000202 1149 301
	<b>TPS-5/5x35</b>	Clear	5/35	100	7315881149605	10000204 1149 608
	<b>TPS-6/5x35</b>	Clear	6/35	100	7315881150007	10000214 1150 002
<b>Screws for PVC trunking</b>						
Screw with large thin head and integrated washer. Phillips cross recess, twin thread, fully threaded. Gives very good pressure when fixing plastic trunking. For red screw plug. Material: Hardened steel, electroplated.						
 P89052	<b>TSC-32</b>	—	4.2/25	100	7315883782022	20034494 3782 020
	<b>TSC-33</b>	—	4.2/31	100	7315883782039	20034495 3782 030
<b>Installation screw with cup washer</b>						
Installation screw with cross-slotted head type PH2. Sharp point, fully threaded. High pitch for quick mounting. Provided with a cup washer for screw-head protection. To be used when installing single-insulated wire in the trunking. Material: Hardened steel, electroplated, and PP.						
 P90119	<b>TFT-IS5x32</b>	—	5/32	100	7332418018203	20057379 4020 210
<b>Screw bit</b>						
Screw bit with 1/4" hexagonal fixing for Phillips cross-slotted screw. Suitable for use in a narrow space. Material: Hardened steel.						
 P89048	<b>PH 2x50</b>	—	6/50	2	7315880055273	20056742 1772 056
	<b>PH 2x110</b>	—	6/110	2	7315880055297	20056739 1772 058
<b>Drill bits</b>						
Hammer drill bit for use in concrete, bricks, stone and rock. Material: Chrome vanadium steel with high quality tungsten carbide tip.						
 P89049	<b>THB 4x110</b>	—	4/110	1	7315881788866	10000496 1788 868
	<b>THB 5x110</b>	—	5/110	1	7315881788927	10000497 1788 926
	<b>THB 6x110</b>	—	6/110	1	7315881789023	10000502 1789 023